







SI series energy power batteries



Introduce

TCSN SI series utilizes high-rate, long-life LFP batteries and features a built-in, high-quality BMS. Compared to traditional lead-acid batteries, these lithium batteries demonstrate exceptional performance and longevity, while also offering superior charging capabilities; they are widely applicable across a variety of scenarios, such as low-speed electric vehicles and sightseeing shuttles.

Features

- 
Shock-resistant design
 Automotive-Grade Vibration-Resistant Design
 Unafraid of Bumps — Rock-Solid Stability
- 
Safe and worry-free
 Using LFP batteries ensures high safety, no fire, and no explosion.
- 
Worry-Free After-Sales Service
 5-Year Standard Warranty
 Long-Lasting Protection — Extendable
- 
Low self-discharge
 Significantly Reduced Power Loss During Hibernation
 Monthly Self-Discharge $\leq 2\%$
- 
Intelligent Management
 Remote Backend Monitoring
 Data Management
- 
Environmentally Friendly
 Practicing the Circular Economy
 Enabling Clean Operations

Performance

Model	Dubhe SI76-200
Performance	
Cell	Square LFP 200Ah
Terminal	M8
IP Grade	IP65
Self Discharge	$\leq 2\%$ /Month
Cycle Life	6000times(80%DOD)
Rated Charge Current	100A
Max. Charge Current	200A
Rated Charge Voltage	81.6~82.8V
Charge Cut-off Voltage	87.6V
Balancing Voltage	$>81.6V$
Rated Discharge Current	100A
Max. Discharge Current	200A
Rated Discharge Cut-off Voltage	67.2V
Min. Discharge Cut-off Voltage	$>60V$
Short Circuit Current	Approx.3000A

Performance parameters	
Capacity	200Ah(0.5C@25°C)
Nominal Voltage	76.8V
Energy	15360Wh
Weight	~125kg
Dimensions	1000*290*280mm
Communication interface	RS485/CAN/Bluetooth
LCD Panel	4.2-inch touch screen
Storage Temp	-5°C to 35°C
Discharge Temp	-20°C to 55°C
Charge Temp	0°C to 45°C

Size

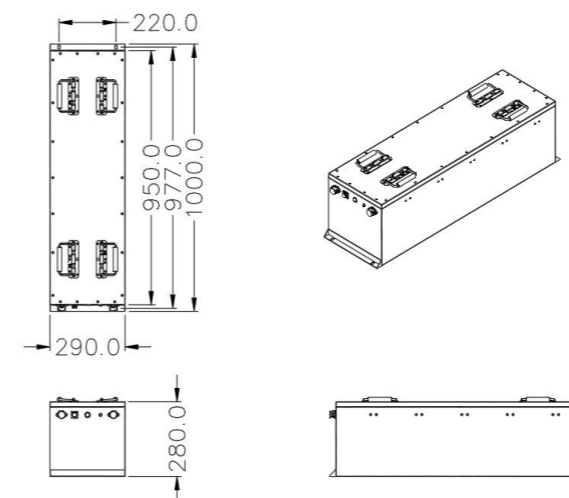

Compliance

Certifications	Cell UN38.3
	Battery UN38.3
Transport Appraisal	UN3480,CLASS 9

System Management Diagram

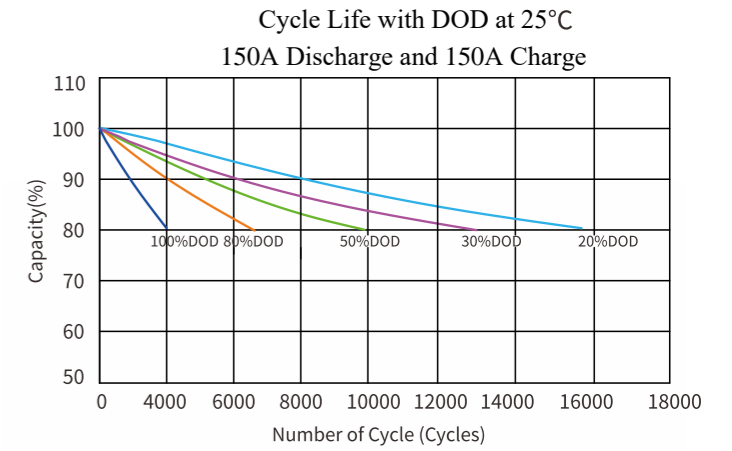
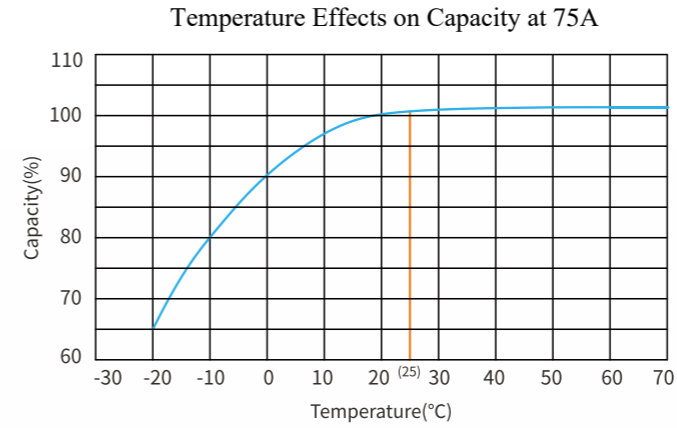
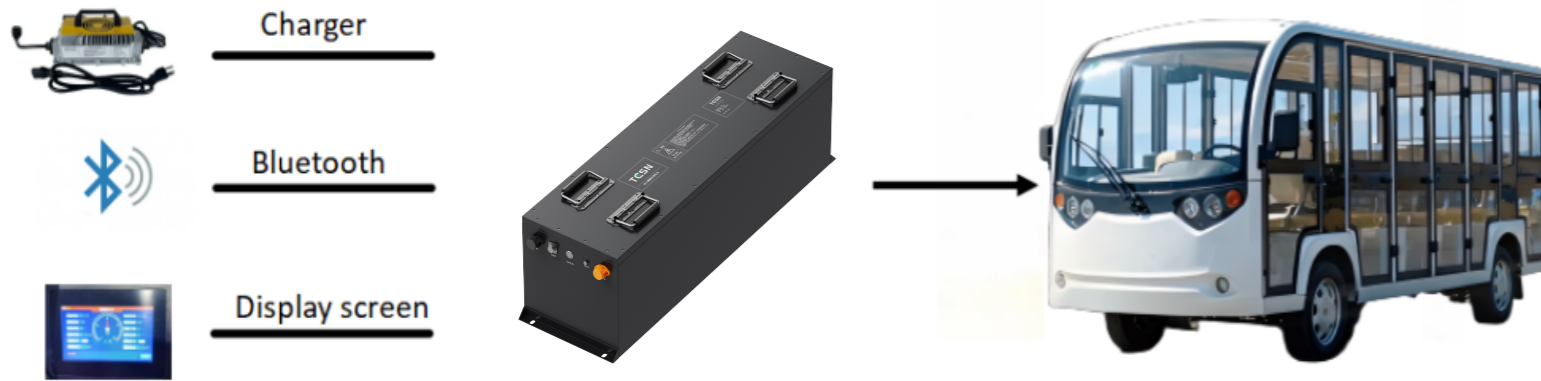

Characteristics Curve

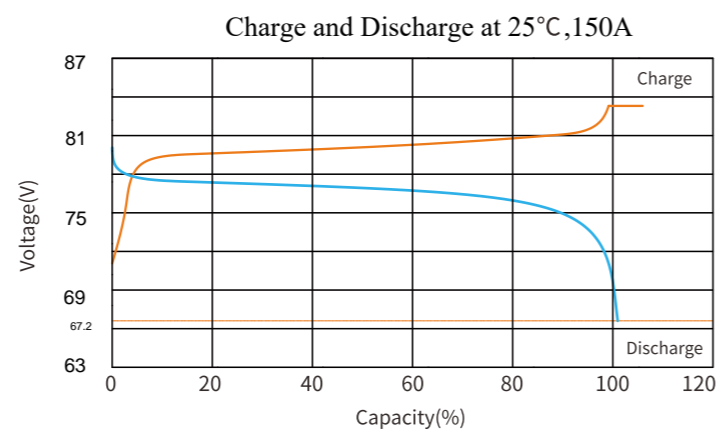
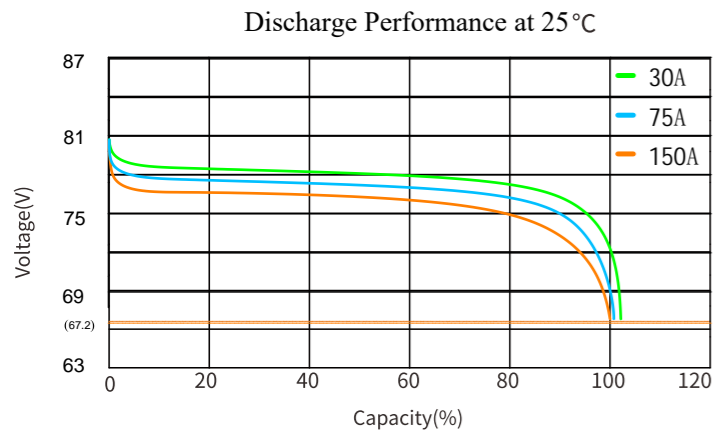

Cautions

1. Do NOT short circuit, crush or disassemble.
2. Do NOT heat or incinerate.
3. Do NOT immerse in any liquid.
4. Store at 50% capacity. Recharge every 3 months. The storage area should be clean, cool, dry and ventilated.
5. Disconnect charging source prior to connecting or disconnecting battery terminals.
6. Do not dispose of batteries in a fire as they can explode.
7. Do not open, alter, or mutilate batteries. Released electrolyte is harmful to skin and eyes. It may be toxic.
8. Do not mix different types and brands of lithium-ion batteries.
9. Do not dispose in trash, follow local regulations and manufacturer's instruction.
10. See installation instructions before connecting to the supply.
11. The battery cabinet receives power from more than one source. Disconnection of all DC sources is required to De-energize this unit before installing or servicing. Wait 5 minutes before opening the unit.
12. Do not install on or over combustible surfaces.
13. Refer to manual before servicing.
14. Do not touch bare terminals.